

APPENDIX TO RULE 4121:1-3-10

Pole Scaffold—Single and Double Type.

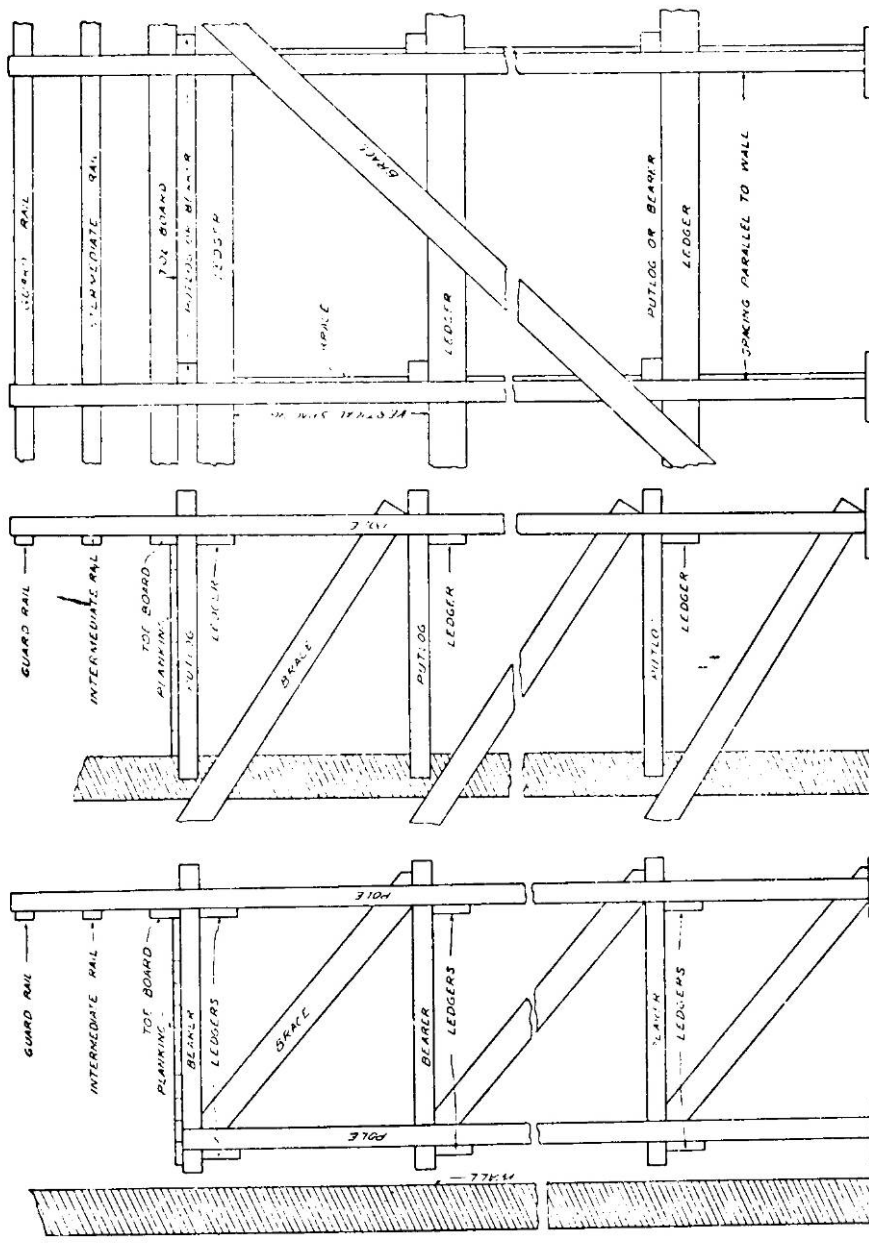

APPENDIX TO RULE 4121:1-3-10 - continued

Swinging Scaffold—Ladder Platform and Longitudinal Beam Type.

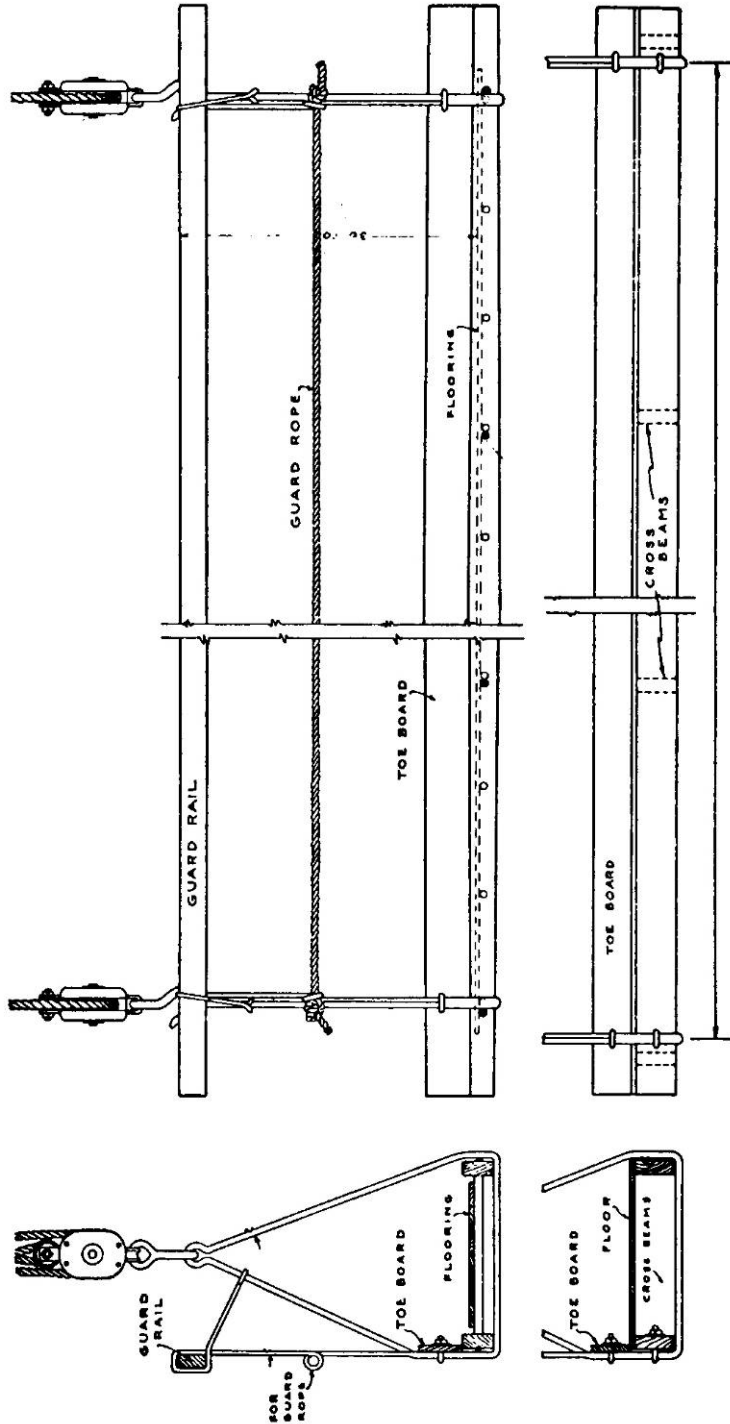

APPENDIX TO RULE 4121:1-3-10 - continued

Suspended Scaffold.

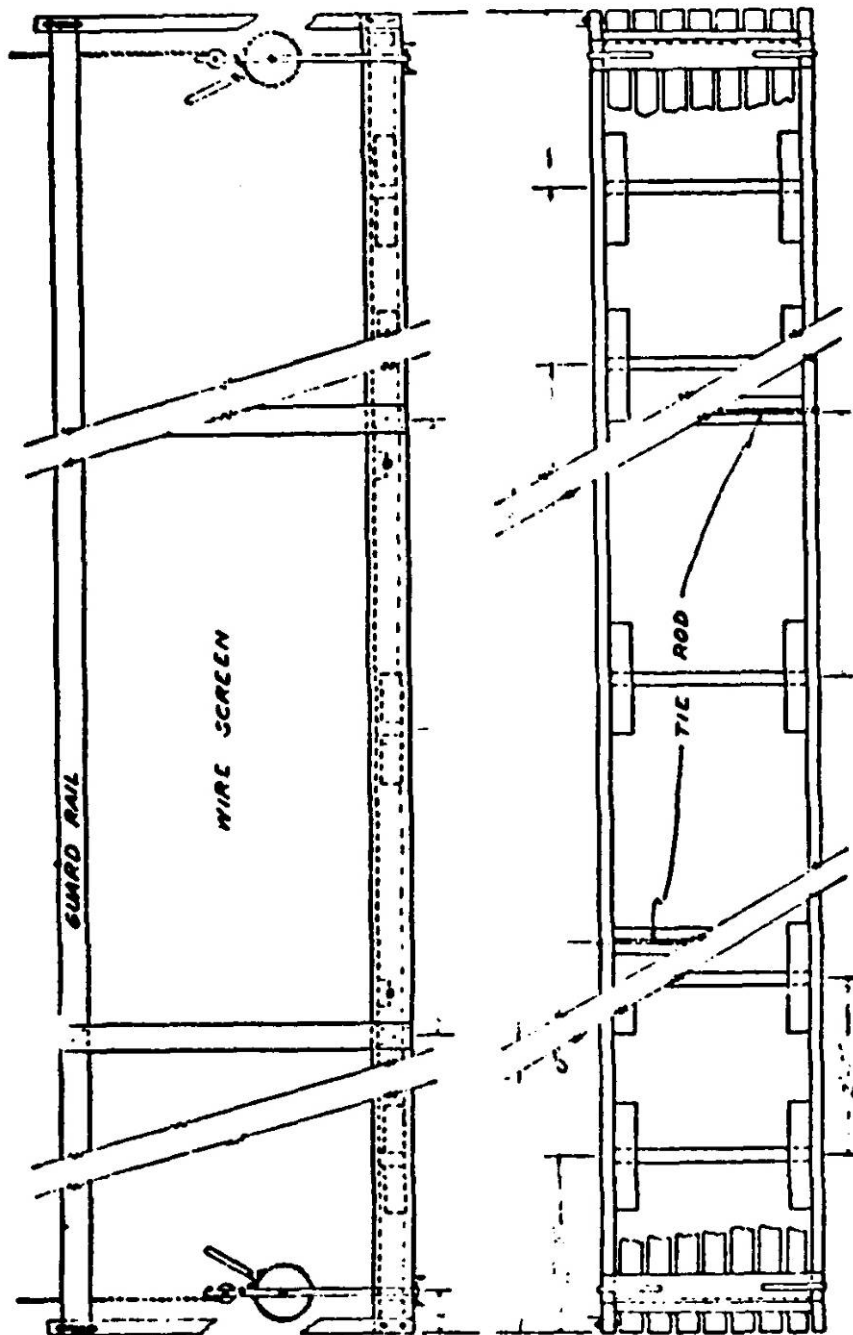

APPENDIX TO RULE 4121:1-3-10 - continued

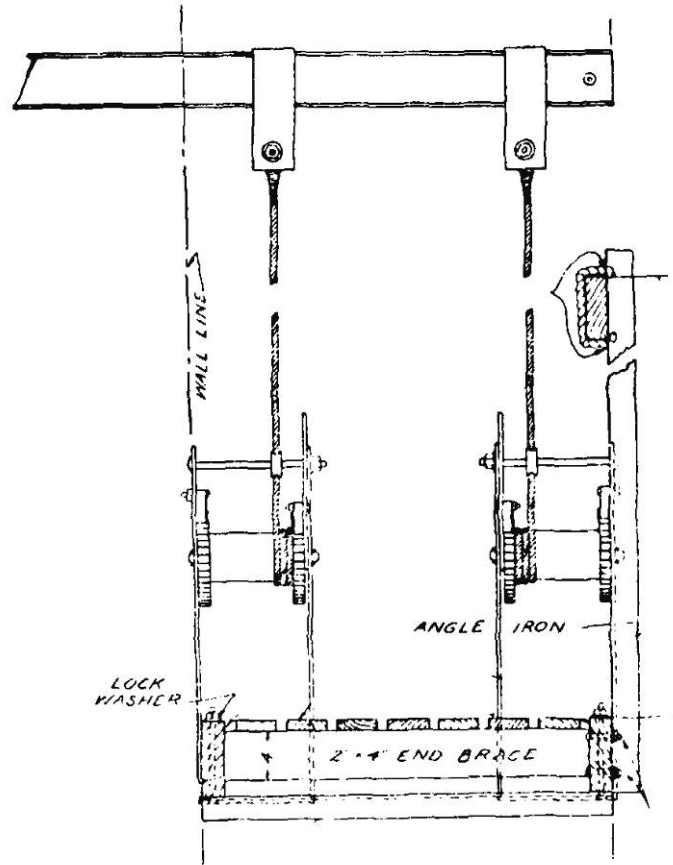

End View of Suspended Scaffold.

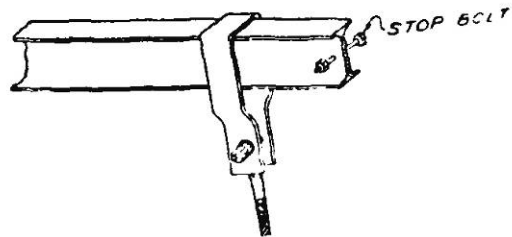

Suspended Scaffold—Thrustout.

APPENDIX TO RULE 4121:1-3-10 - continued

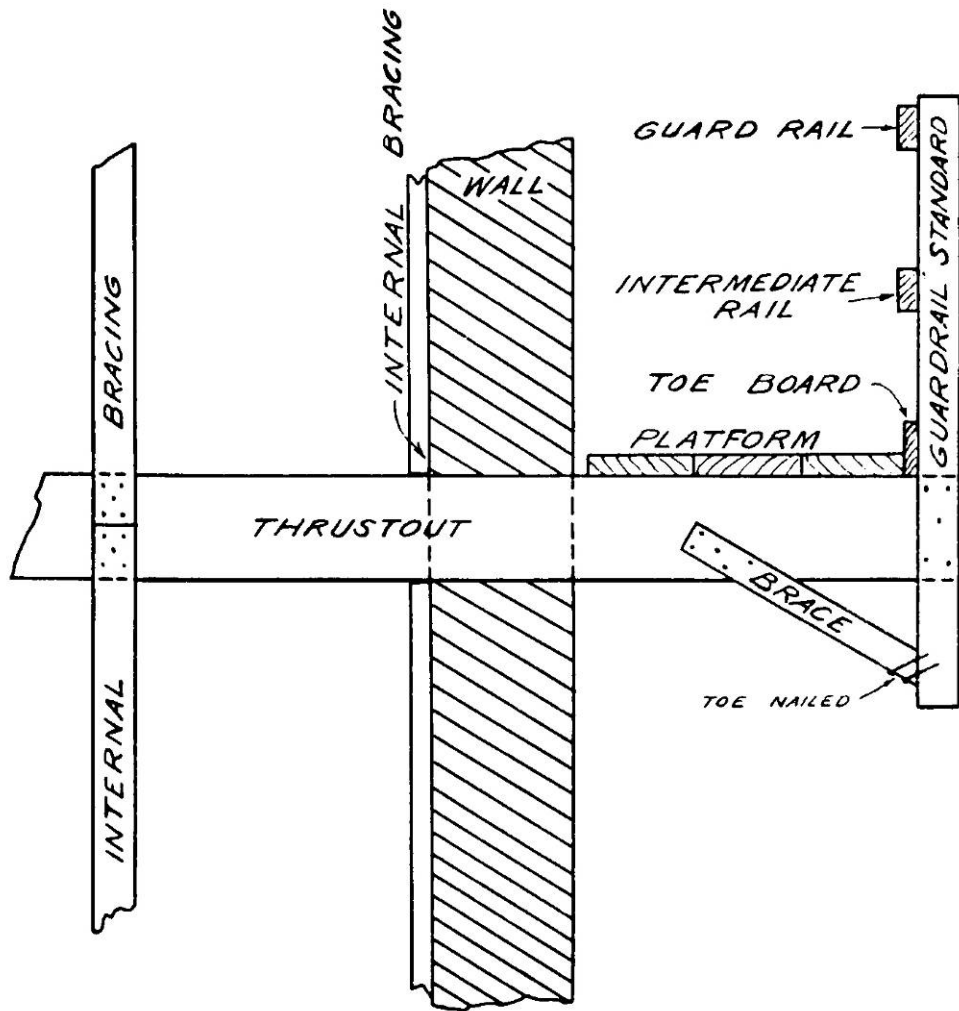

Outrigger Scaffold.

APPENDIX TO RULE 4121:1-3-10 - continued

Scaffold Horse.

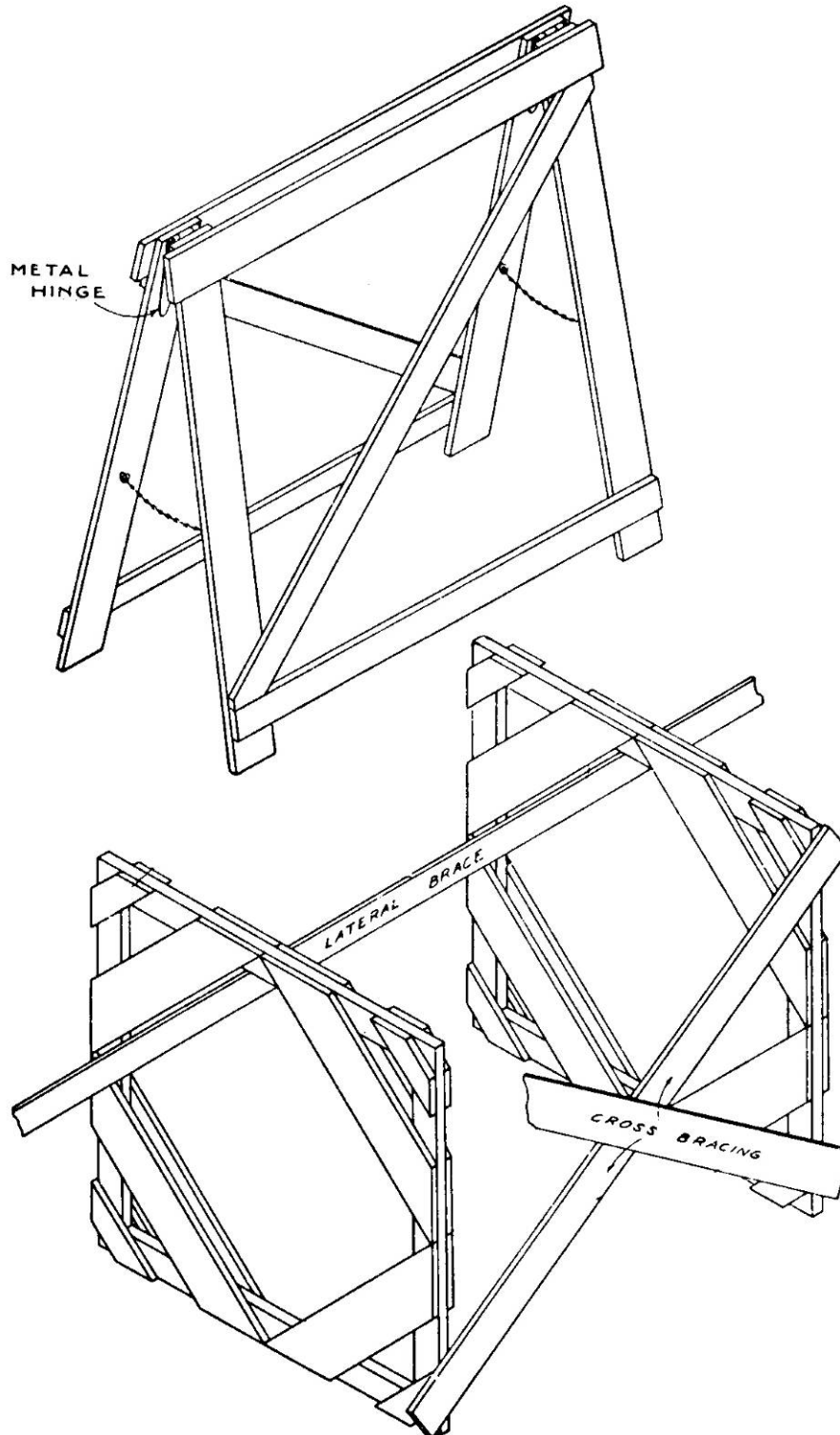

Masons' Square Scaffold Frame.

APPENDIX TO RULE 4121:1-3-10 - continued

Scaffold Jack.

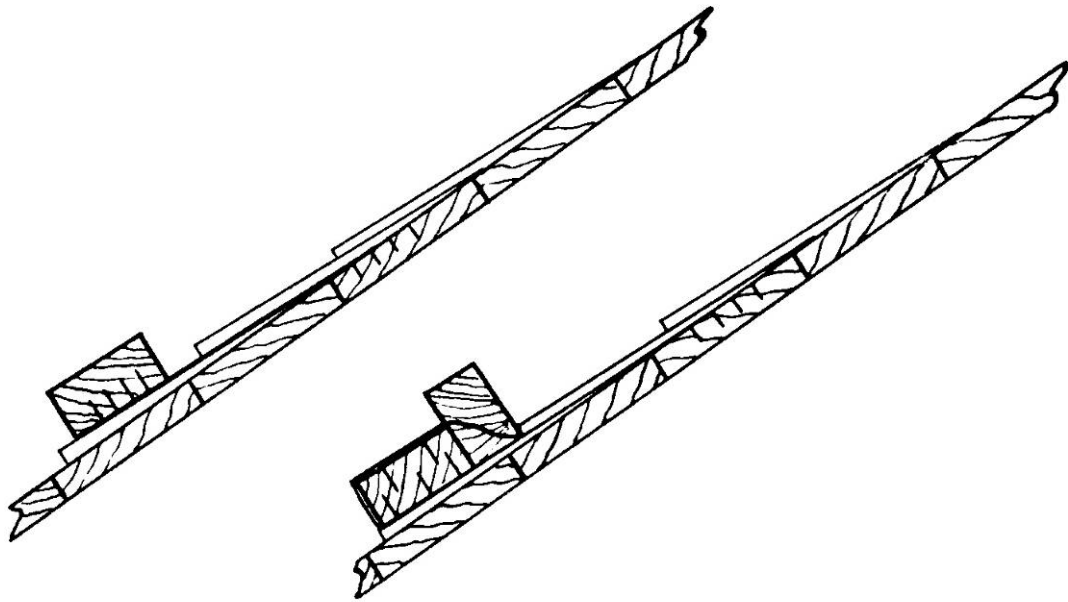
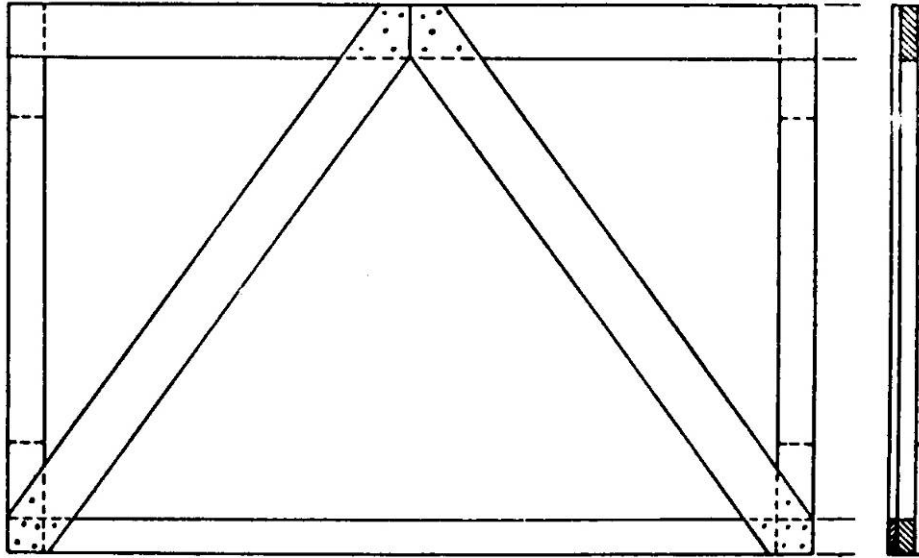

Footlocks.

APPENDIX TO RULE 4121:1-3-10 - continued

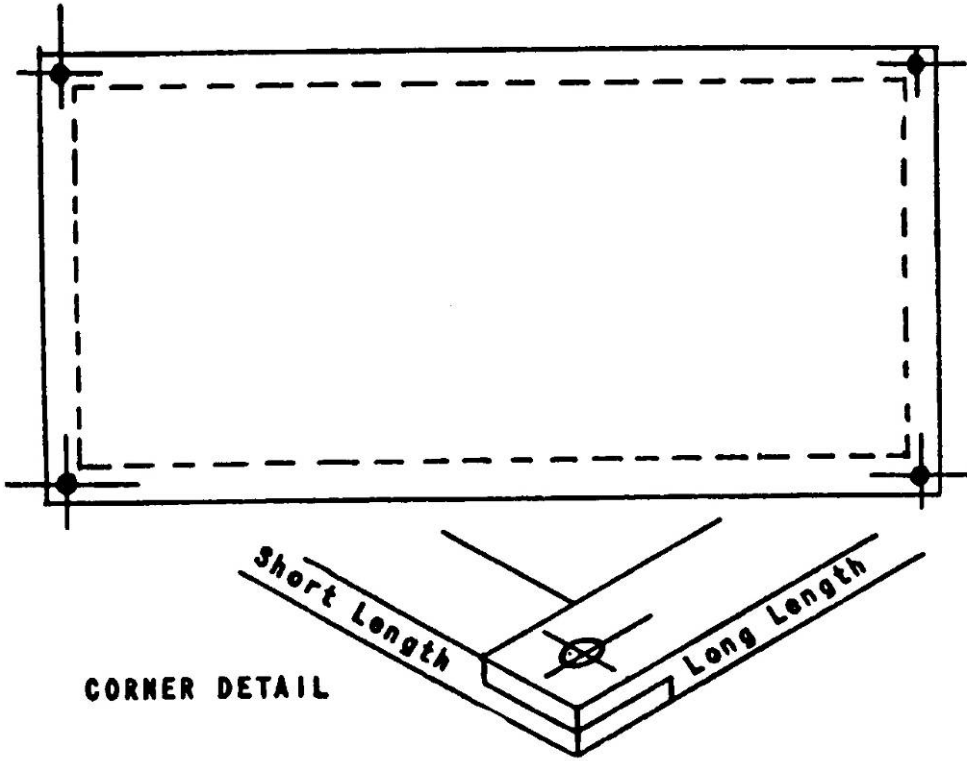

Float or Ship Scaffold.

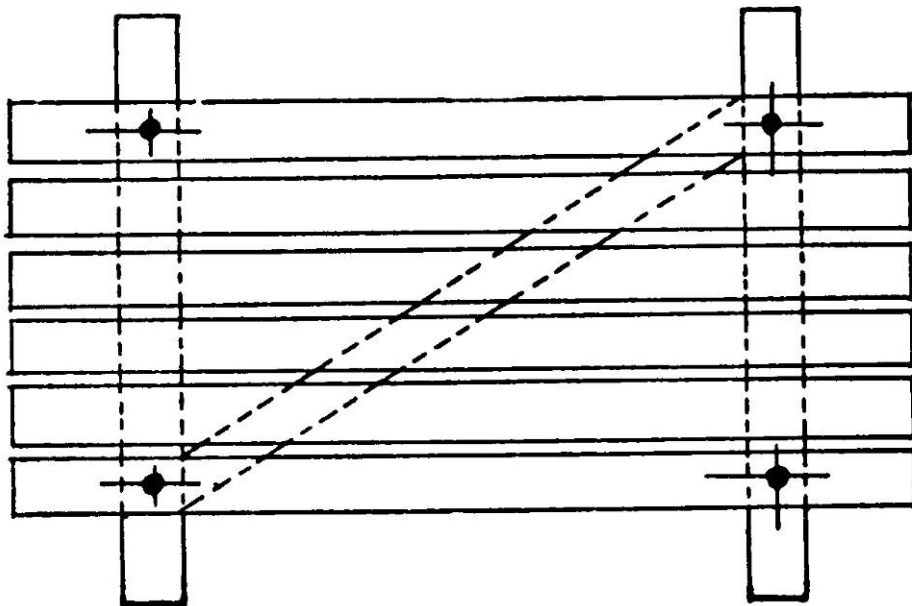

APPENDIX TO RULE 4121:1-3-10 - continued

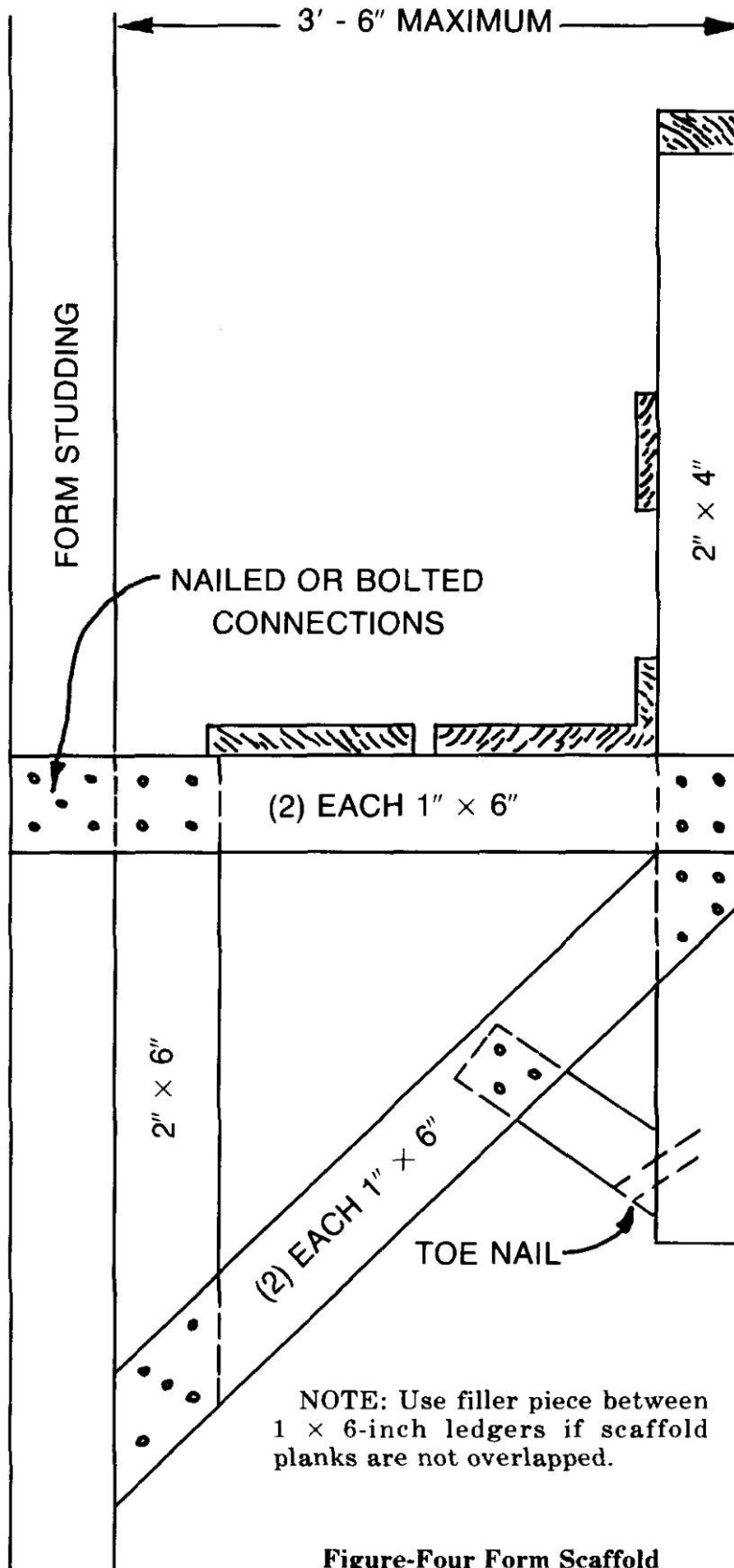
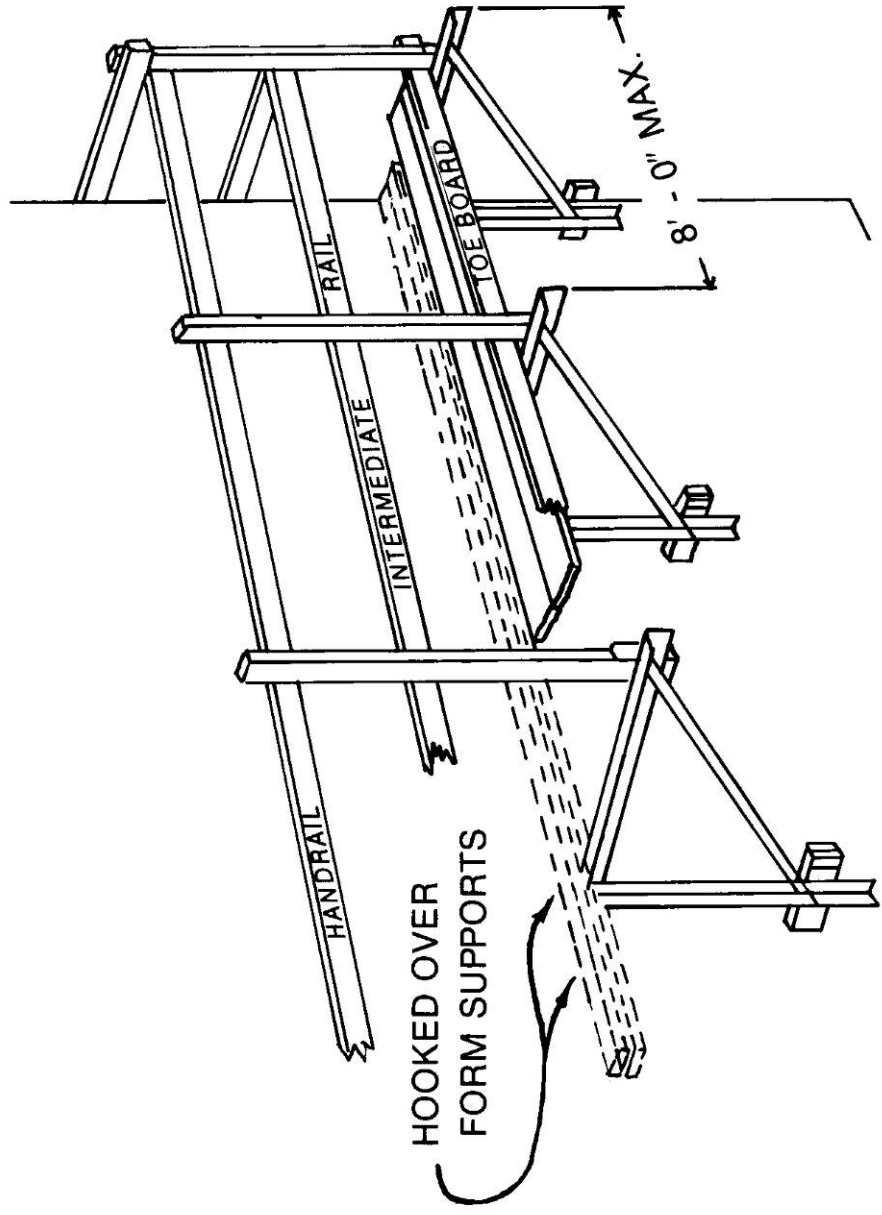

Figure-Four Form Scaffold

APPENDIX TO RULE 4121:1-3-10 - continued



Metal Bracket Form Scaffold

APPENDIX TO RULE 4121:1-3-10 - continued

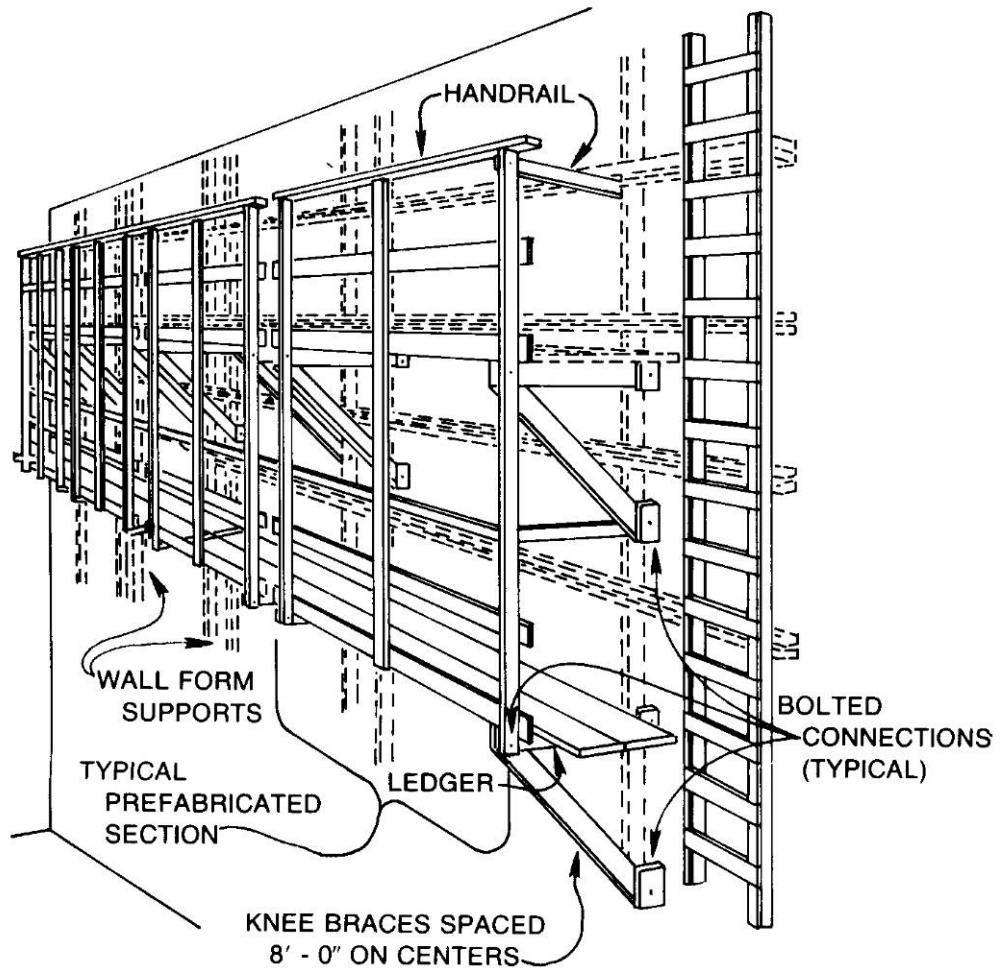

NOTE: Scaffold can be prefabricated for attachment to wall forms at various positions, or it can be made as a permanent part of a movable form panel.

Wooden Bracket Form Scaffold